

环境可控
高效丰产

以色列



无土栽培

新技术

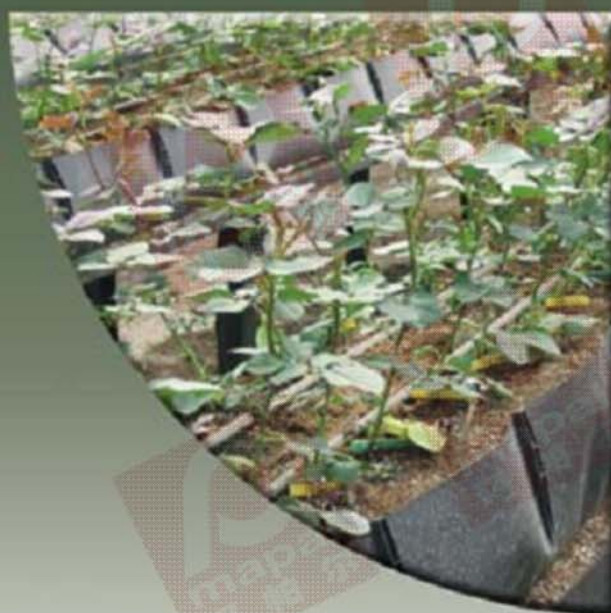
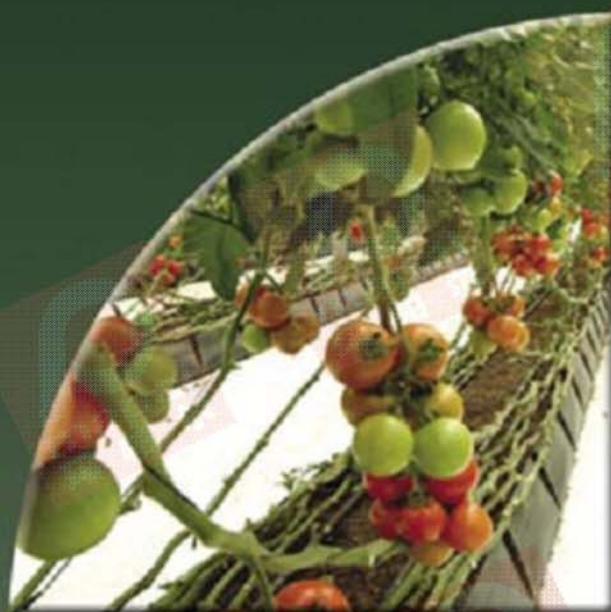

适合于蔬菜，玫瑰，切花，香草，草莓，以及种植袋种植系统的无土栽培

一 Troughing System - Instructions for Use 种植槽系统-使用说明

将PP卷打开并按所需长度进行裁剪

1

Spread the polypropylene roll in place and cut to required length

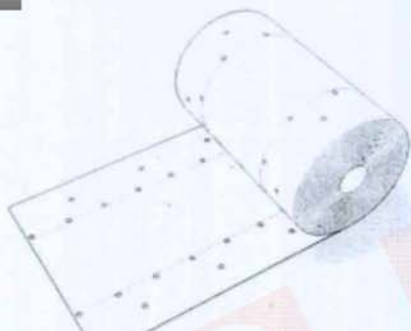

沿折印将种植槽折起来

2

Fold the trough along the creases

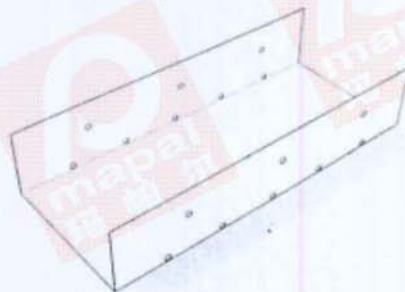

将塑料绳穿过槽边孔及固定梢,并在底部固定

3

Attach the hole in the trough and the peg and lock into the bottom position. Attach the "pen clip" of the peg onto the upper lip of the trough

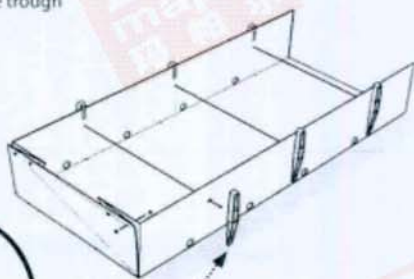

种植槽固定梢

将种植槽的托盘部分折起并封口,并沿两侧装上固定夹.安装排水格(可选).

4

Fold and close drainage envelope. Arrange clips along both sides of envelope. Place drainage spacer on top of envelope-(optional)

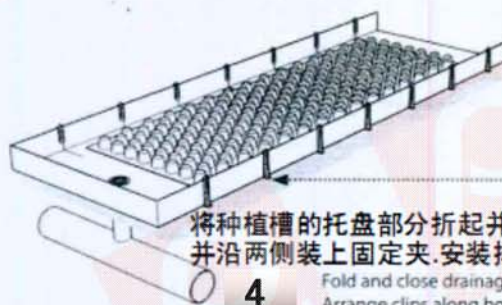

安装种植槽与托盘

5

Assembled trough and envelope

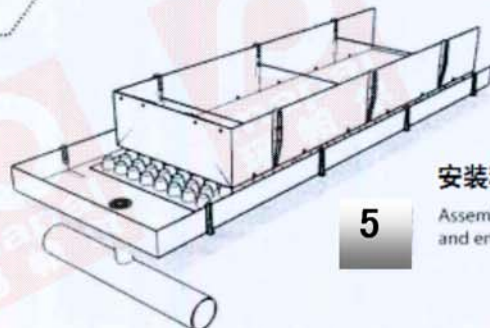

二 Lysimeter

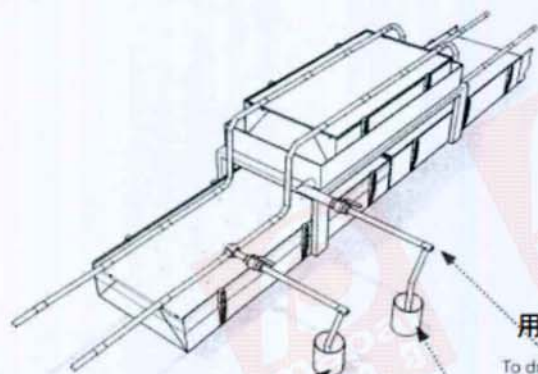

用于收集与监测滴灌水

Container for collecting, testing and measuring drip irrigation water

用于排水

To drainage

用于收集和监测排水水

Container for collecting, testing and measuring drainage water



三 Hanging Gutter System for Strawberries 草莓的悬吊水槽系统



四 Assembly of Hanging Gutter System 悬吊水槽系统的组装

1. Spread the polypropylene container on a flat surface and fold along the crease marks in order to facilitate construction.



2. Fold the polypropylene container, making sure the top straps and end flaps are properly attached.



3. Insert the polypropylene container into the PVC drain collection gutter.



4. ASSEMBLY OF THE DRAIN END SECTION
排水槽端头的安装
Insert the 1 1/4" drain unit into the hole in the PP end section.



Fold and construct the end section with the plastic rivets provided.

将PP槽端部折起并用所提供的塑料铆钉固定
Attach the PP end section to the PVC gutter by drilling holes in the appropriate position and inserting the rivets provided.

在PP槽的适当位置打孔并插上铆钉
将PP槽端部与PVC水槽固定起来

PVC 排水槽

Collection Gutter

PP 塑料种植槽

在适当的位置打孔

五 Trough + Drainage Spacer for Growbags (Coir & Rockwool)

用于种植袋（椰糠或岩棉）的种植槽+排水格

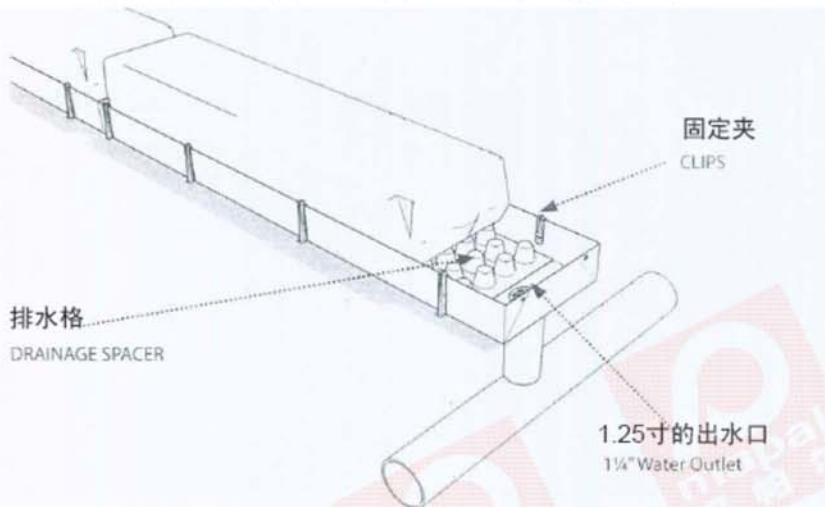

六 Drainage Collection Gutters for Growbags (Coir & Rockwool)

用于种植袋(椰糠或岩棉)的排水收集槽

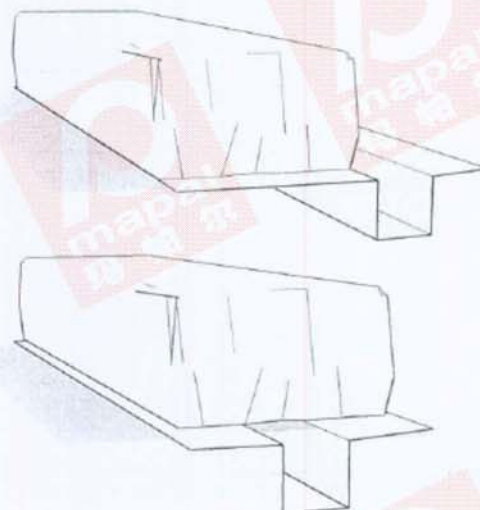
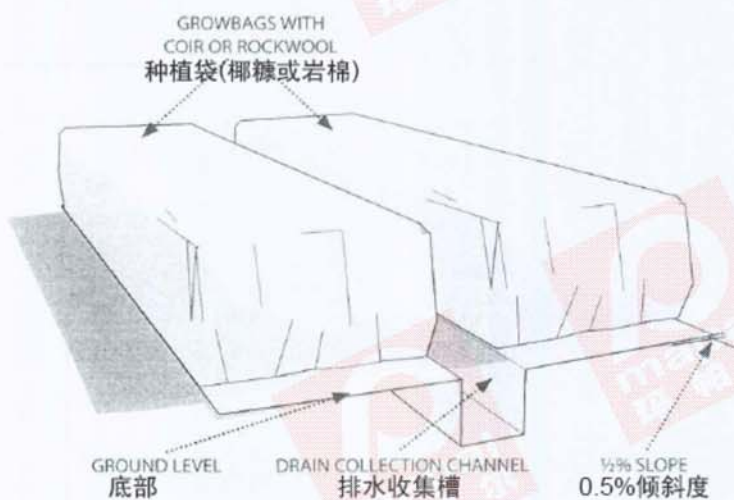

七 Galvanized Metal Elevation Trough System 镀锌铁架排水槽系统

'V' SHAPE V字型

STANDARD SHAPE 标准型



ELEVATED METAL CONSTRUCTION 金属支架

DRAINAGE ELEMENT 排水单元

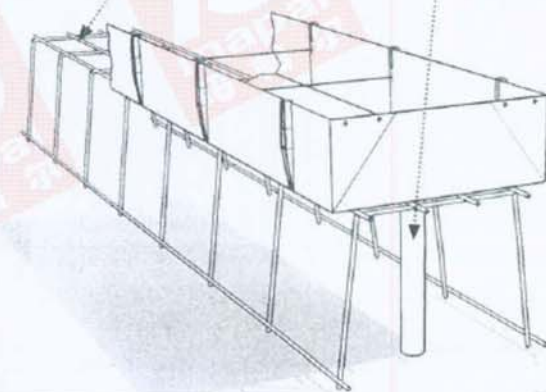

八 Trough with Side Drainage Holes 带侧排水孔的种植槽

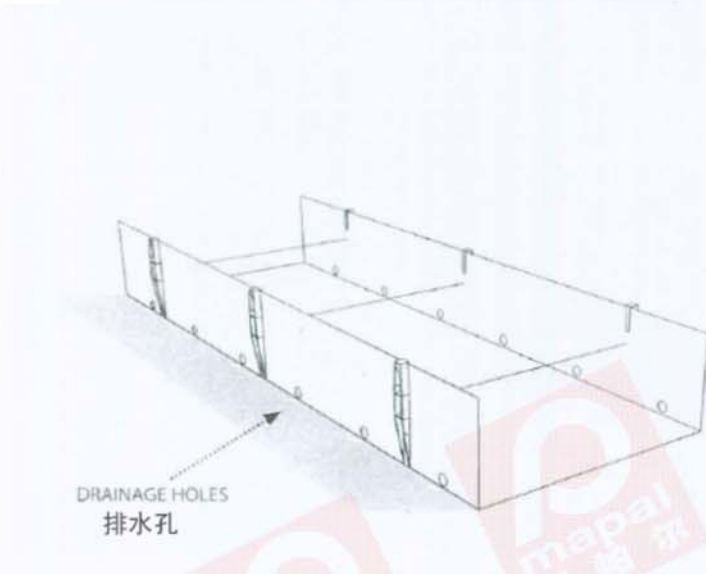

九 Trough without Drainage Holes 不带侧排水孔的种植槽

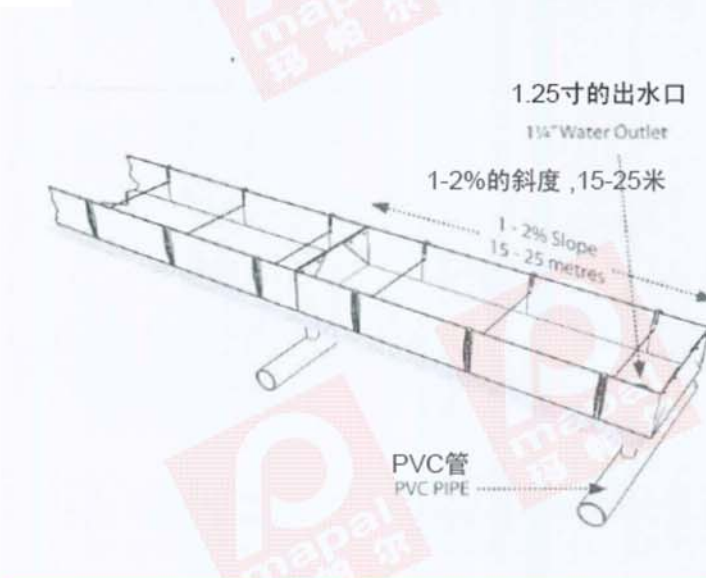

十 Trough with Drainage Envelope & Drainage Spacer 带托盘与排水格的种植槽

带托盘与排水格的种植槽

TROUGH WITH SIDE DRAINAGE HOLES 带有侧面排水孔的种植槽

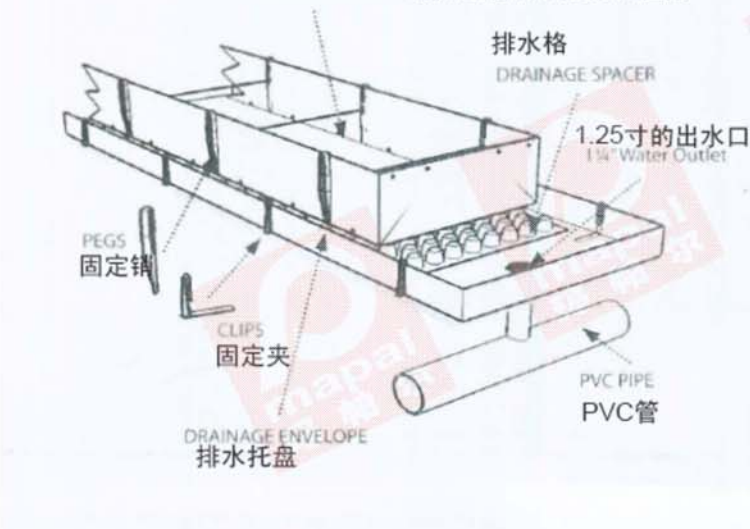

十一

Water Recycling System in a Greenhouse 温室的水循环系统

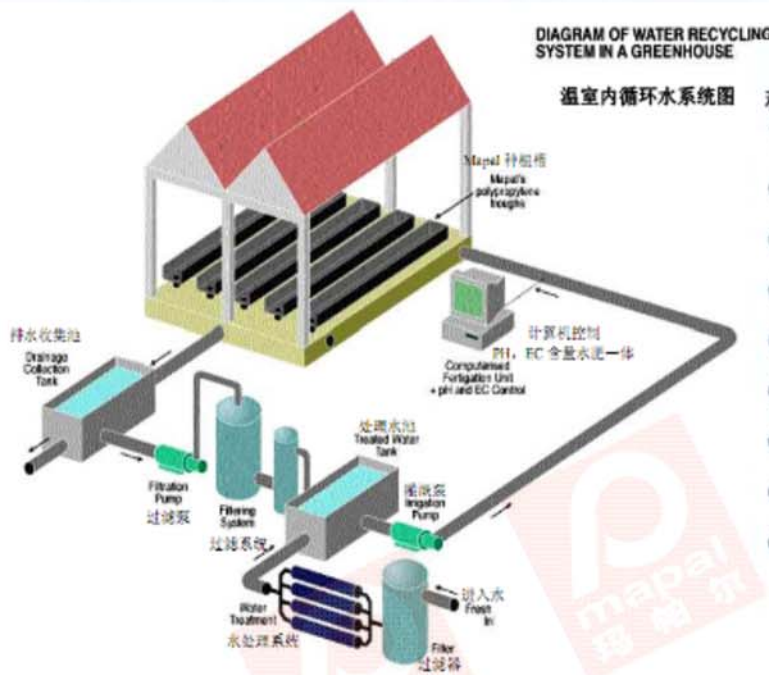

DIAGRAM OF WATER RECYCLING SYSTEM IN A GREENHOUSE

温室内循环水系统图

种植槽系统

TROUGH SYSTEM

- Resistant to UV 抗紫外线辐射
- Resistant to steam sterilization 抗蒸气消毒
- Resistant to all chemicals and acids 抗化学与酸剂
- Flexible dimensions (length, width, depth) 灵活的尺寸(长/宽/深)
- Suitable for all kinds of substrates 适用于各种基质
- Suitable for any drainage system 适用于各种排水系统
- Easy to assemble 易于安装
- 5 year warranty 5年质保

十二

Hints for Growing in Soilless Culture in Troughs 无土栽培种植槽的注意事项

- **ROOTING:** Roots are spread and not confined to a limited area. They can seek and share water and fertilizers all over the trough space.
生根: 根系会发散开并不局限于一个有限的空间, 它们会在种植槽内找到足够的空间并吸收水份和肥料
- **IRRIGATION:** A simple drip line is more than enough. Expensive drip system is not required.
灌溉: 一个简单的滴灌带就足够了, 无需昂贵的滴灌系统
- **CLIMATE AND HUMIDITY CONDITIONS:** Better aeration, temperature moderation and humidity circulation.
气候与湿度条件: 有较好的通风, 温湿度调节的循环系统
- **STERILIZATION:** It is easy and safe to sterilize the substrate while inside the trough using any recommended system: steaming, chemical or solar.
消毒: 用所有规范的蒸汽/化学或辐射方法都可以对种植槽内的基质进行简便易行并有效的消毒
- **REPLANTING:** The previous crop is easily removed in one piece from the trough. New plants can be easily planted after sterilization.
再植: 可简便地从种植槽的一片中将前期作物移除. 新作物同时亦可简单地在进行消毒后栽种

IMPORTANT INFORMATION FOR USERS: 用户要特别注意

The required slope for assembling the troughs is around 1.5%. Uniformity of the 安装种植槽的要求斜度是约1.5% slope is important. 均匀的斜度非常重要

Trough systems sketches

种植槽系统

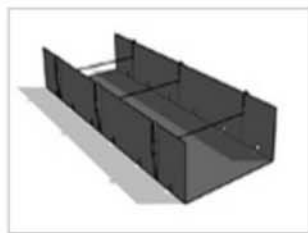

带排水孔

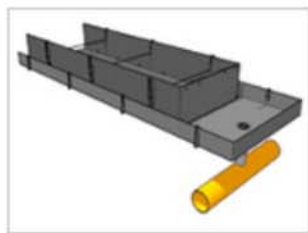

带托盘

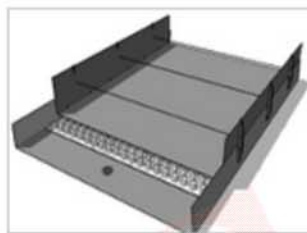

带托盘与排水格

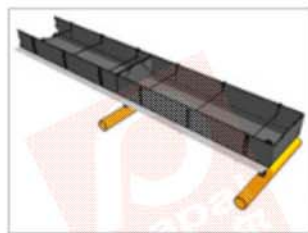

无排水孔

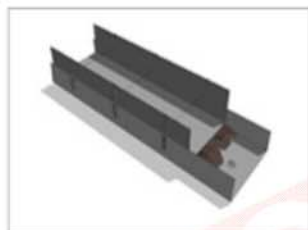

带托盘与凝灰岩

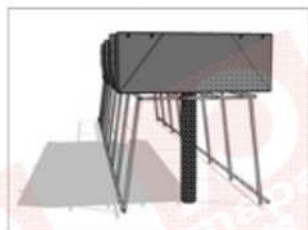

带金属提升架

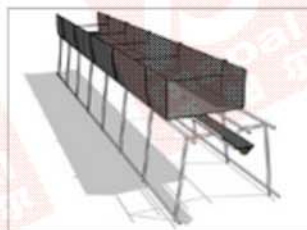

带 V 型金属架

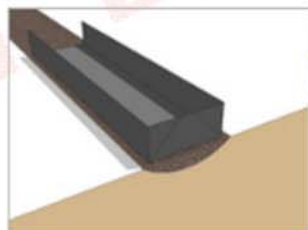

带排水孔与一个收集槽



带托盘与两个收集槽

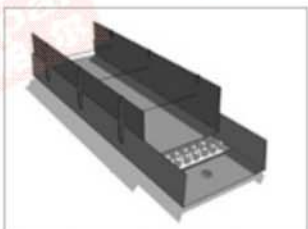

带托盘与排水格

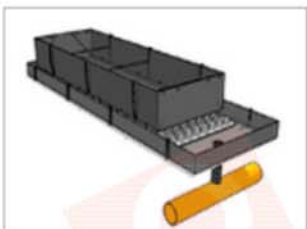

带托盘与小排水格

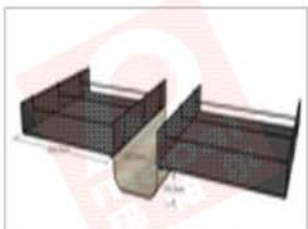

双槽并联+排水槽

Grow bag drainage collection systems

种植袋排水收集系统



用于一个种植袋带排水格的排水槽



排水槽

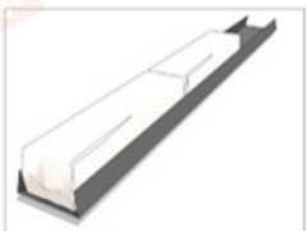

带种植袋的排水槽

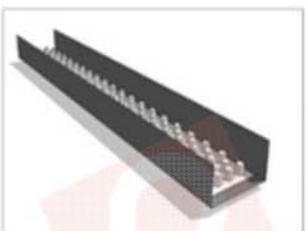

带排水格的排水槽

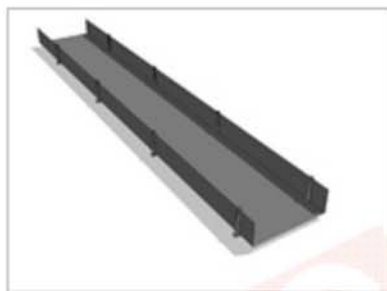

带夹子不带排水格的托盘/槽



双种植袋系统的排水槽/托盘

产品系列

PVC 110 Gutter System

PVC110 型水槽系统

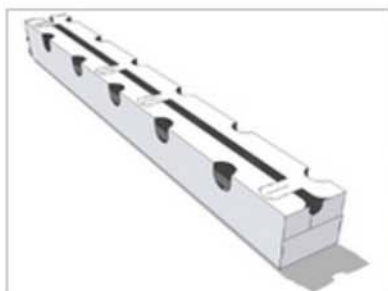

用于 PVC110 水槽的 PP 盒

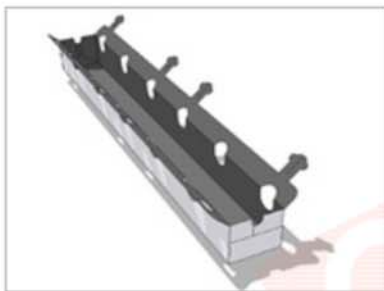

填充前的 PP 盒

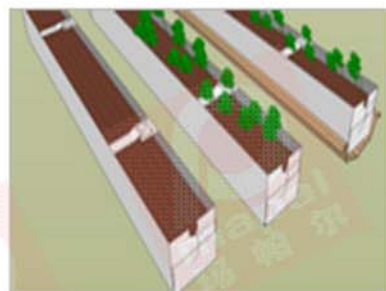

PVC110 系统的 PP 盒打开状态

PVC 210 Gutter System

PVC210 型水槽系统

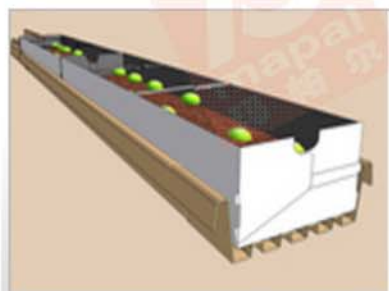

PVC210 系统的 PP 盒打开状态

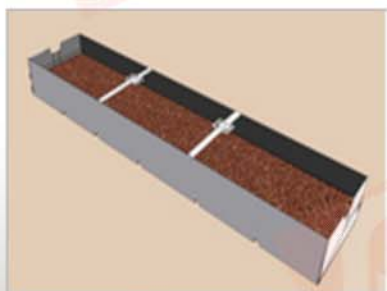

打开的 PVC210 盒



PVC210 安装情形

Drainage Spacer

排水格

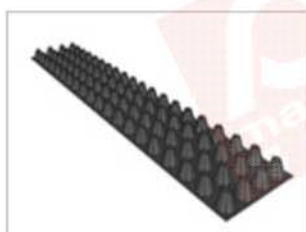

200 型排水格



300 型排水格



VERY BERRY 排水格



顶端开口排水格



Rain gutters

雨水槽

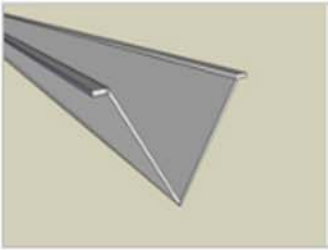

V 型水槽

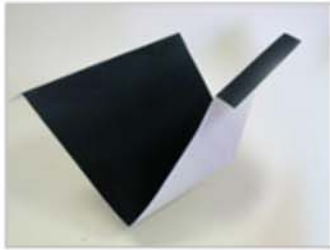

V 型水槽实物



V 型槽的使用



西班牙温室上 V 型槽的使用

Accessories

配件



铆钉



固定夹 200

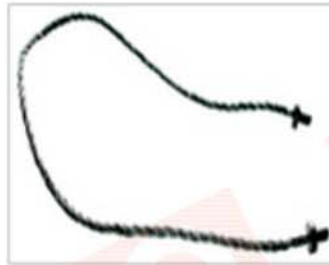

固定绳



固定夹 150 用



夹子



1.25 寸排水出口

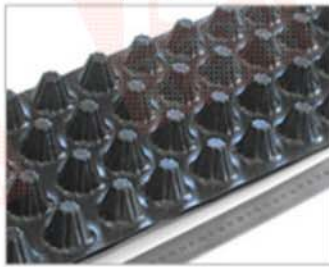

排水格

ELEVATIONS

支架



多功能 H 型支架



金属支架

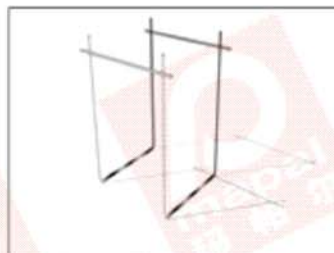

金属支架 2

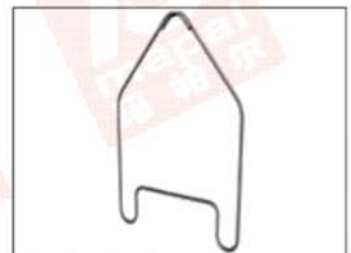

悬吊钩

